

ECK 90

HÖCHENVERSTELLBEREICH

 62,5 –127,5 cm

IDEALE TISCHPLATTENBREITE

 je 110 –200 cm

DYNAMISCHE NUTZLAST

 150 kg

GERÄUSCHPEGEL MOTOR

 max. 50 db

ANTIKOLLISION

 Ja

ANZAHL PAKTE

 2 Pakete

GEWICHT PAKETE

 28 kg + 22 kg

FARBAUSWAHL

BREITENVERSTELLBEREICH (optional erweiterbar)

 jeweils 108 –180 cm (auf 200 cm)

IDEALE TISCHPLATTENTIEFE

 je 60 –100 cm

ANZAHL MOTOREN

 3 leise Motoren

HEBEGESCHWINDIGKEIT

 40 mm pro Sekunde

ELEKTRISCHE EINGANGSLEISTUNG

 110-230 V

MAßE PAKETE

84 x 38 x 15 cm / 111 x 20 x 25 cm

LIEFERUMFANG

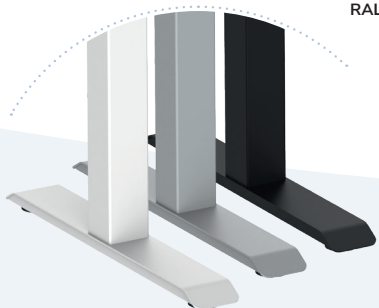
Holzschrauben, Kabelbefestigungen,
verstellbare Nivelliergleiter

weiß-matt
RAL 9010



grau-aluminium
RAL 9006

schwarz-matt
RAL 9005

ECK 90

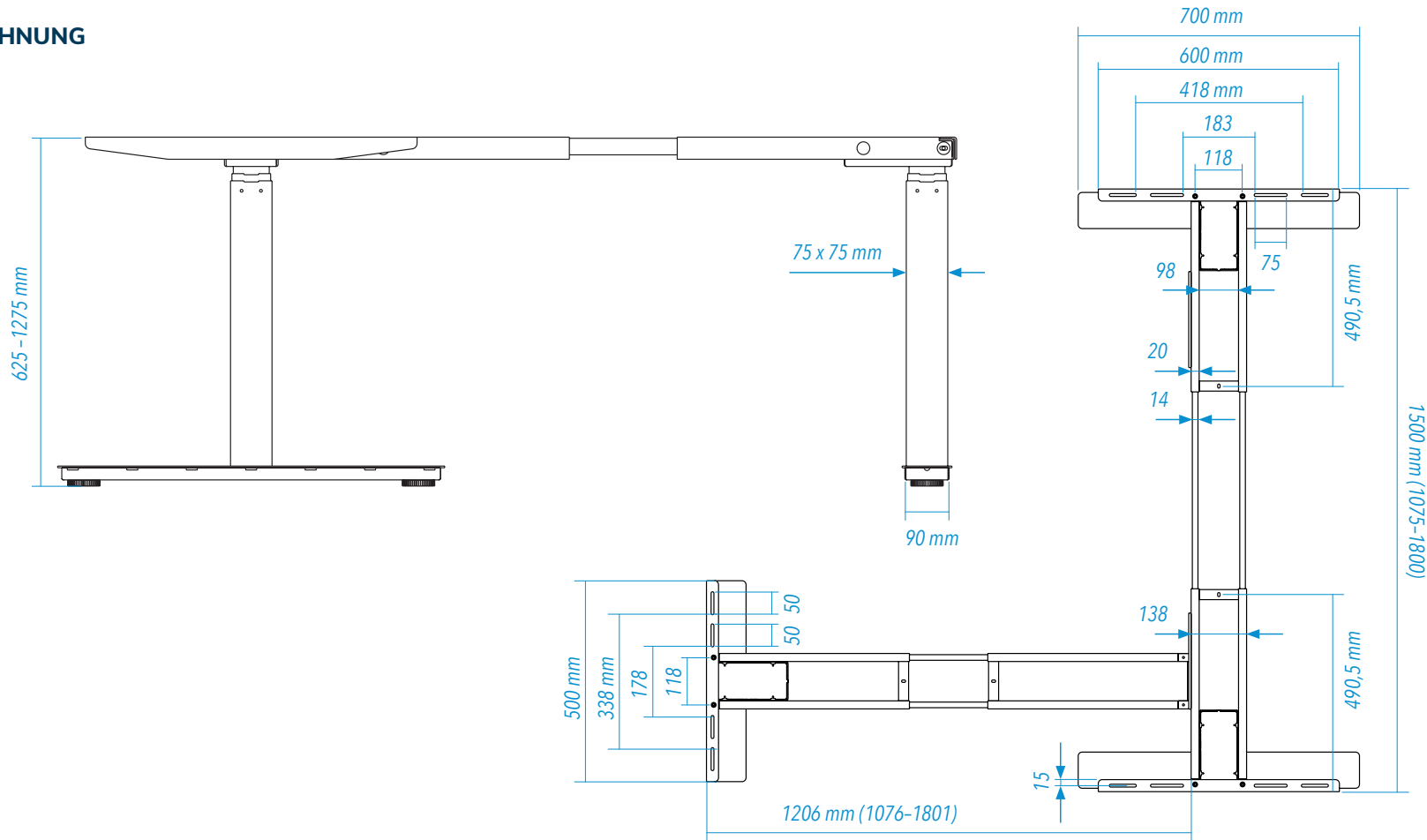

TECHNISCHE ZEICHNUNG



ECK 90

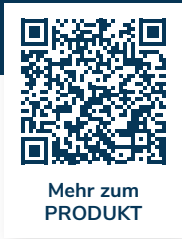

HANDSCHALTUNG

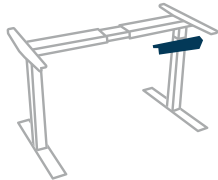

PLATTENTRÄGER

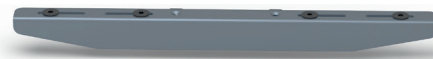
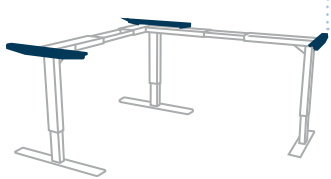

TISCHFÜSSE

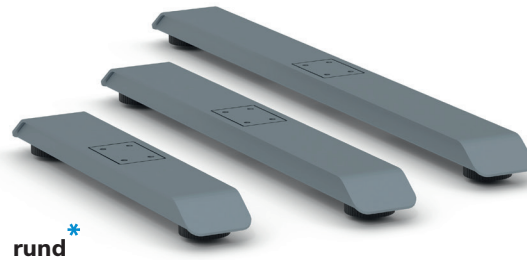
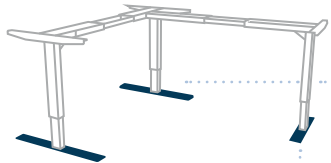

* Gegen Aufpreis möglich.

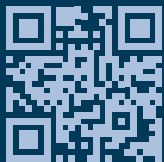

ERGONOMIE-BERATUNG

Bei Fragen oder für eine ausführliche Beratung kontaktieren Sie uns gerne direkt unter:

07633 920 41 41 oder 0157 308 169 87 per E-Mail info@ergoni.de